

Model ECP45 YG

8" - 14 gauge spun aluminum ball
gold anodized

Single sheave truck, cast
aluminum revolving,
non-fouling type

2 Swivel snaps
with covers per halyard

4 Sets of halyard: #10 poly

11'-0" Yardarm

4 - 9" Cast aluminum cleat

Aluminum flash collar

3000 PSI concrete

Hardwood wedges
(supplied by others)

Dry sand tightly tamped
after aligning pole

Foundation sleeve - 16 ga
hot dip galvanized steel

Steel centering wedges

1/4" Steel base plate

1/4" Steel support plate
welded to grounding
spike

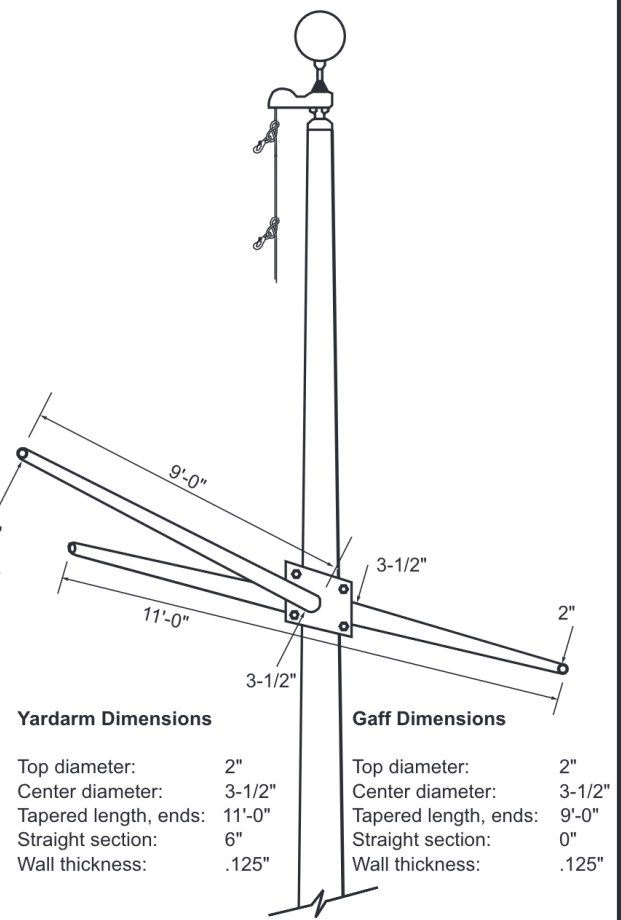
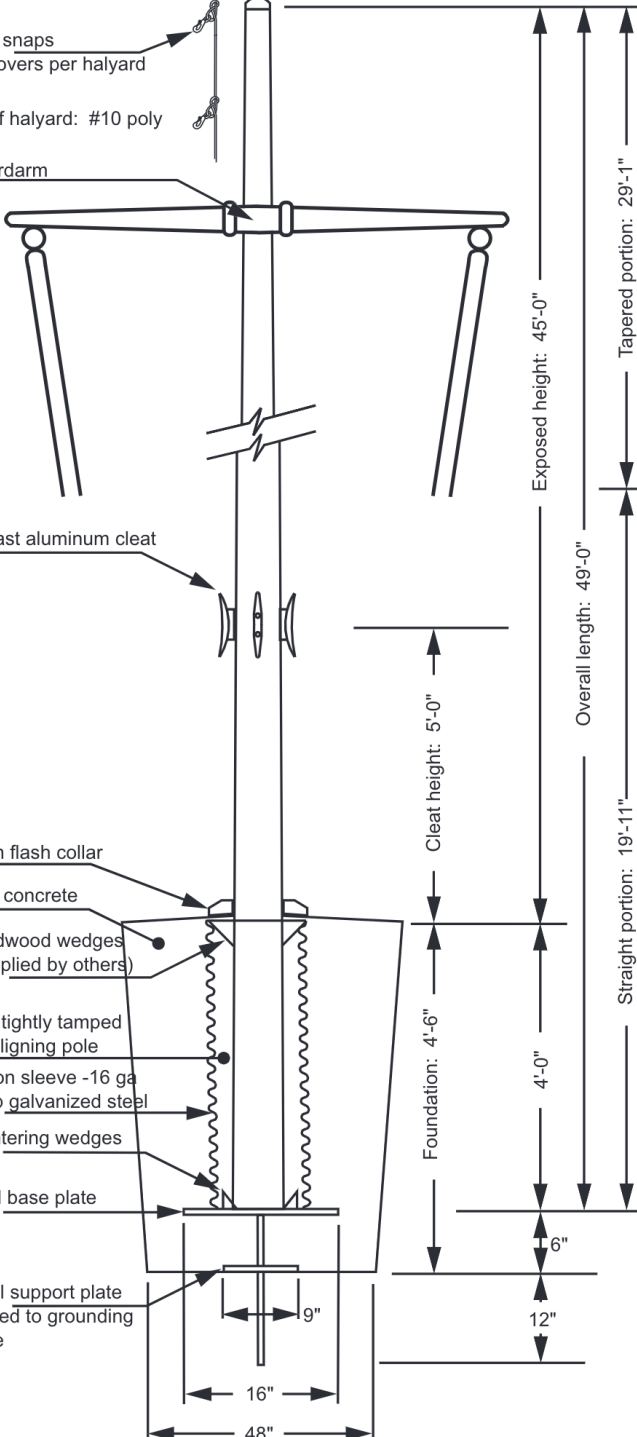

Yardarm Dimensions

Top diameter: 2"
Center diameter: 3-1/2"
Tapered length, ends: 11'-0"
Straight section: 6"
Wall thickness: .125"

Gaff Dimensions

Top diameter: 2"
Center diameter: 3-1/2"
Tapered length, ends: 9'-0"
Straight section: 0"
Wall thickness: .125"

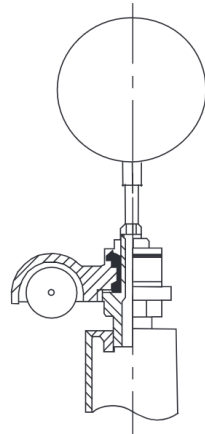

Truck Detail

Aluminum body
Stainless steel ball bearings
Aluminum sheave
Cast aluminum spindle

Project:	Ground set tapered aluminum flagpole: ALLOY: 6063T6	FLAGS.COM	Date:
Location:	Exposed height: 45'-0"	Overall height: 49'-0"	1-800-858-8776
Architect:	Ship in 2 sections	Butt diameter: 8"	1395 NW 17th Ave #112B
Contractor:	Top diameter: 3-1/2"	Wall thickness: .188"	Delray Beach, FL 33445
Customer:	Finish: 100 grit polish		Job: