

Model ECOST 10

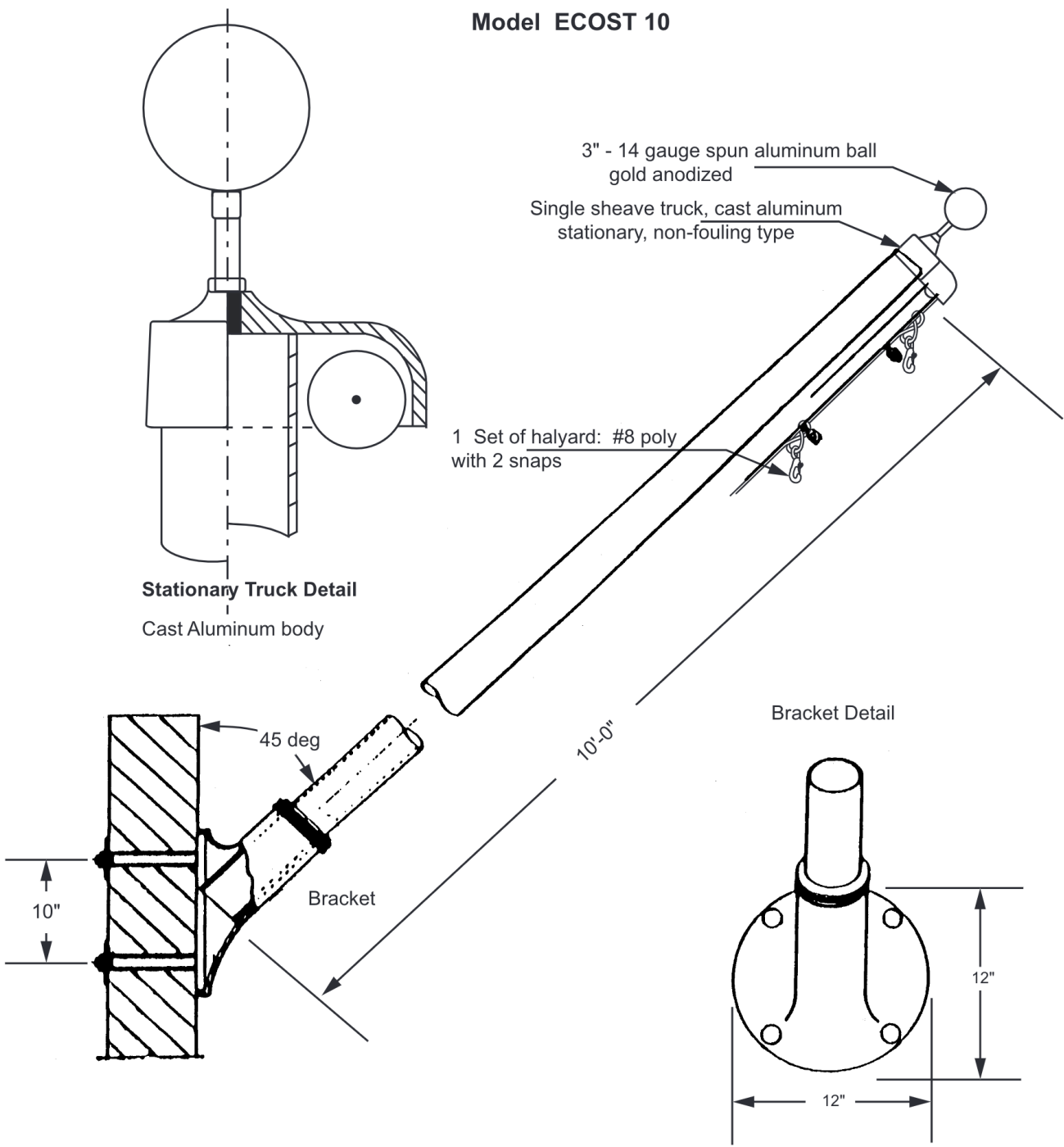

Project:	Cone Tapered aluminum flagpole: ALLOY: 6063T6	FLAGS.COM	Date:
Location:	Exposed height: 10' - 0"	Butt Diameter: 3"	Revision:
Architect:	Ship in 1 section	Top Diameter: 1-7/8"	1395 NW 17th Ave #112B
Contractor:	Wall thickness: .125	Delray Beach, FL 33445	
Customer:	Finish: Satin		Job: